

CPW-900EVS02 **Intelligent Swing Gate Turnstile**

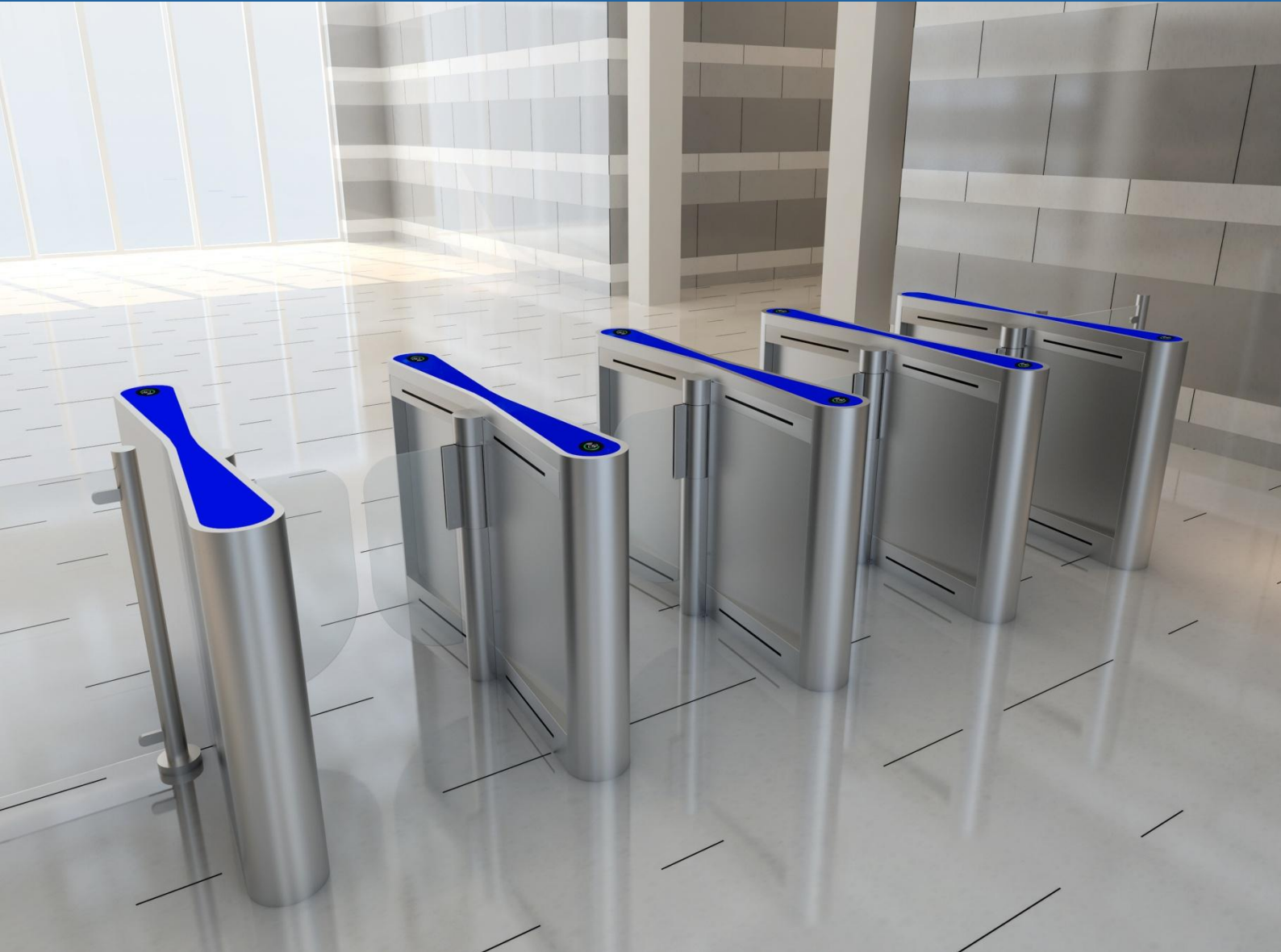

Product Manual

Contents

Product Description.....	1
Structure Chart	2
Dimension Figure (Unit: mm)	2
Product Parameters.....	3
Product Function	3
Custom-made Feature.....	6

Product Description

Intelligent turnstile CPW-900EVS02 is with 'Butterfly' design, pursues the perfect unity of art, fashion and security; the housing made of stainless steel is durable; the mechanism modules are imported from international top brands' DC brushless motors and precise positioning encoder, so as to make sure the swing gate can rotate quickly and accurately, stably and quietly, with low-power consumption, energy conservation and environment protection.

Feature

- ✧ By using 10 pairs of military level high-performance infrared sensors and exact algorithms, the turnstile can accurately detect the pedestrian's passing position to achieve the purposes such as anti-tailgating, anti-reverse passing, anti-clamping and so on.
- ✧ Use the multiple anti-clamping designs to protect the personal safety of passengers in maximum limit.
- ✧ The widen lane is optional for carrying luggage and wheelchair access.
- ✧ Equipped with the dry contact signal input interface, RS485/RS232 interface, TCP/IP interface (optional), compatible with all kinds of access controllers.

Occasion Applications

Suitable for commercial buildings, subways, airports, customs, exhibition halls, government buildings, financial institutions, clubs and other high-end indoor applications.

Structure Chart

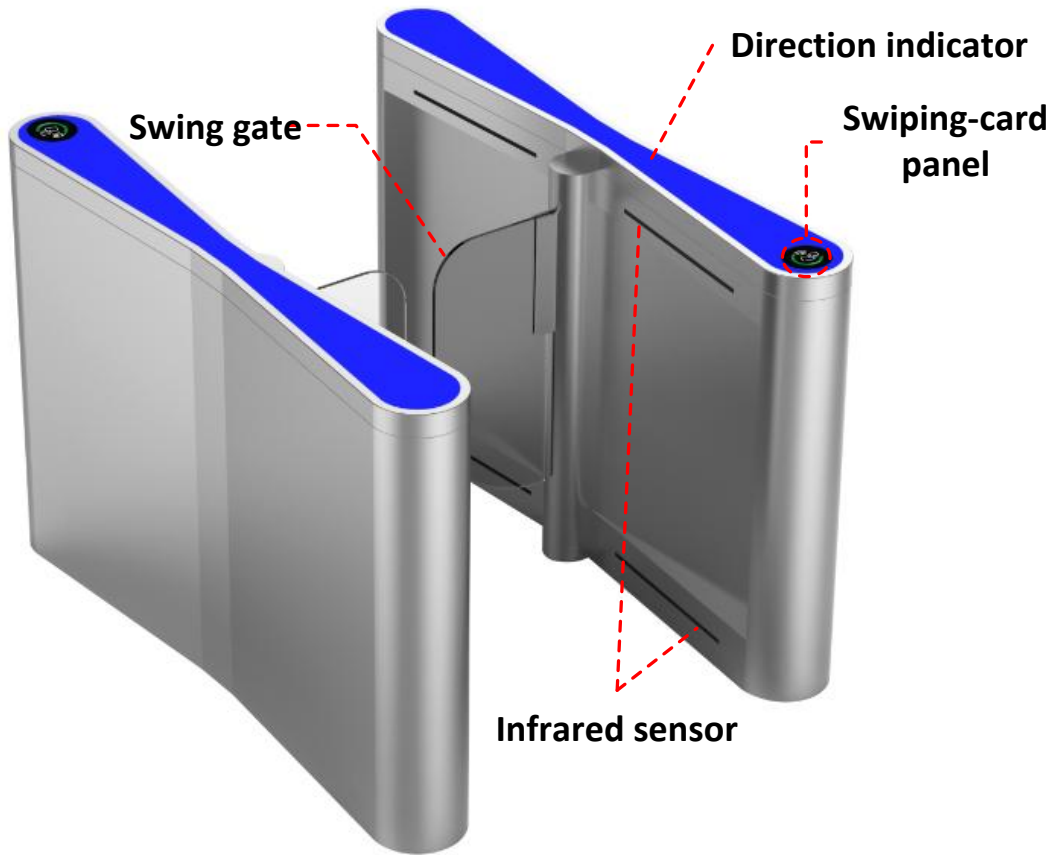

Dimension Figure (Unit: mm)

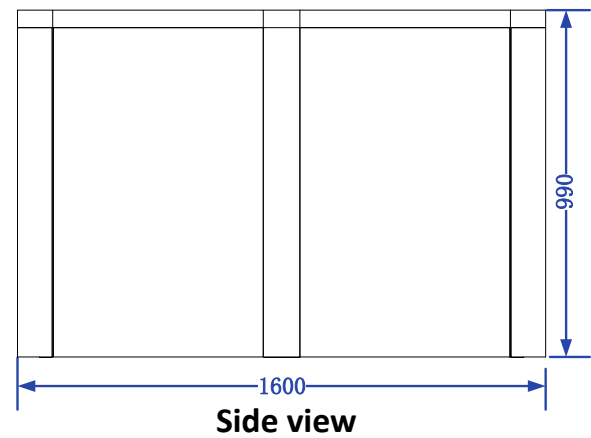
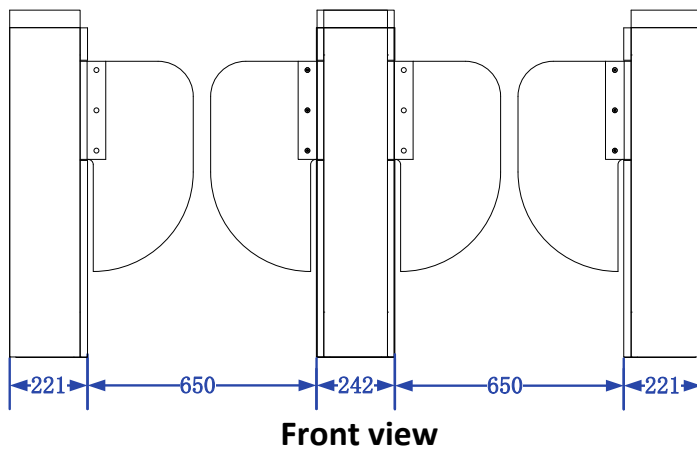

Product Parameters

Structure Parameters	
Housing material	304 grade stainless steel
Surface treatment	Brushed finish
Swing gate material	Organic glass
Technical Parameters	
Normal passing	30 ~ 45 people / min (according to the condition of pedestrians)
Evacuation passing	60 people/min (according to the condition of pedestrians)
Opening speed	0.3-0.6s
The turning angle	±90°
Operation temperature	- 20℃~60℃
Electric Parameters	
Power supply	100-240VAC, 50/60Hz
Rated power	100W
Input/ Output signal	12 channels relayoutput signal/ 8-channel dry contact signal input
Communication interface	RS485 / RS232; TCP/IP interface (customizable)
Driving motor	DC brushless motor
Positioning Method	Use the encoder to position the swing gate accurately
Method of motor control	Using high-performance DSP chip

Product Function

● Basic Function

- **Passing mode switching function:** The entry and exit can be set independently **【controlled mode】** / **【 free mode 】** / **【 forbidden mode】**
- **Automatic reset function:**The turnstile will open swing gate after receiving the valid opening signal when standby. The swing gate will return to the hindered zero position automatically under the following situation:
 - (1) Within the allowed time,pedestrians have been detected to pass through the passageway in

specified direction;

(2) Over the allowed time, there is no people has been detected to pass through the passage.

- **Self-recovery function:** The swing gates do not return to the hindered zero position because of human intervention. After revoking human intervention, the gate automatically return to the hindered zero position.
- **Automatic adjustment function:** When the turnstiles need to re-adjust because of mechanical wear, the main control board can adjust automatically, accurately and conveniently.
- **Memory function of passing requests:** When more than 2 passing signals are given at the same time (including the same direction and opposite direction), the system will remember all the passing requests and finish them one by one. The number can be up to 255.
- **Direction indicator:** The direction indicator is installed on the top of the housing cabinet to indicate the valid passing direction.

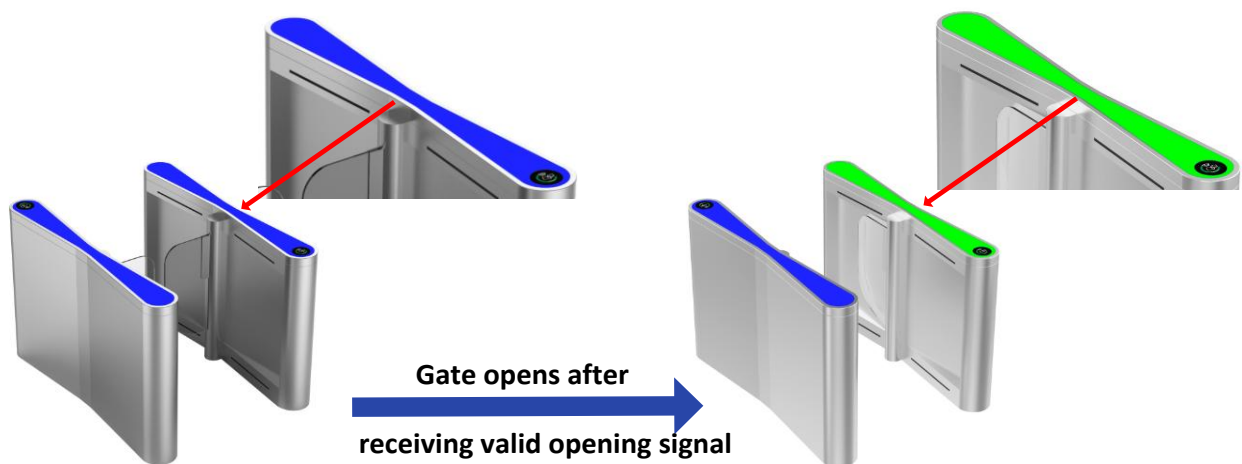

- **Compatibility:** Equipped with the dry contact signal input interface, RS485/RS232 interface, TCP/IP interface (optional), compatible with all kinds of access controllers.

● **Security Design**

- **Self-check function when power on:** The system will self-check routinely and alarm when the power is on, and intelligently detect the key hardware and function. Find the hidden danger within the shortest time!
- **Open gate when power off:** Adopt the leading mechanical structure by original creation; the system will open the gate automatically when power off or manually push the gate to be open so as to

evacuate people conveniently, which meets the firefighting requirement.

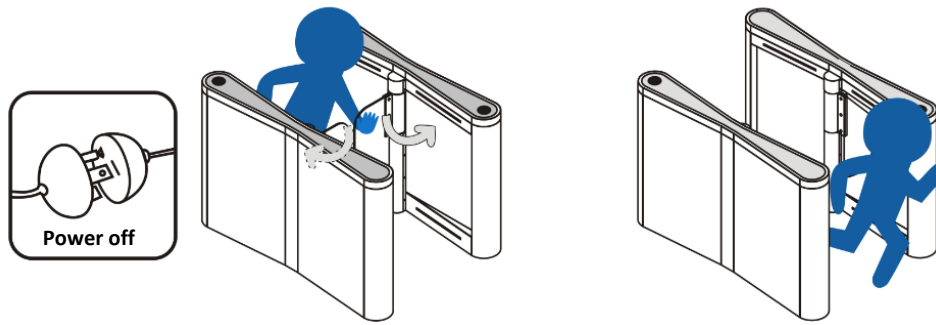

➤ **Anti-clamping function:**

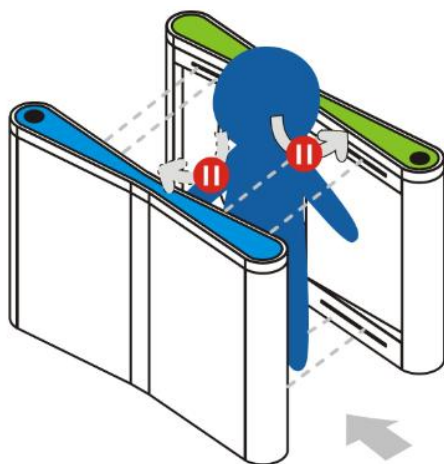

Infrared anti-clamping

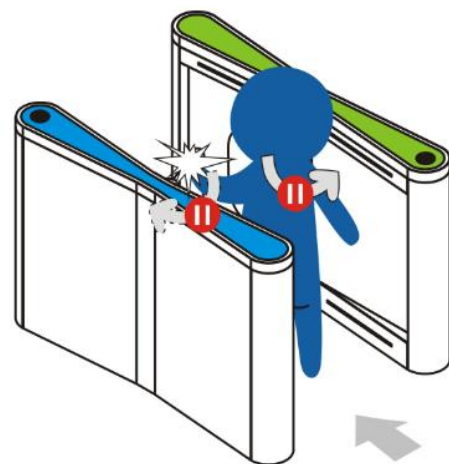

Machinery anti-clamping

(1) **Infrared anti-clamping:** Install multiple-pairs of infrared detectors near the swing gates' moving area (anti-clamping area). Once people or thing is detected within the anti-clamping area, the swing gate will automatically stop moving; until people or thing leaves the anti-clamping area, the swing gate will continue to move.

(2) **Machinery anti-clamping:** The swing gate will automatically stop moving when it encounters obstacles; the impulse force is within the safety range when the swing gate is moving.

- **Anti-collision function:** When the gate is locked, it can support the impulse force within the safety range. The gate can be manually pushed slowly when the impulse force is over the safety range, to protect the mechanism and pedestrian, and then recovers automatically.
- **Emergency escape function:** Equipped with emergency escape control device, the system can automatically open swing gates to evacuate pedestrians, which is convenient.
- **Intelligent linkage alarm:** Illegal traffic events can be linked with other alarm monitoring equipment:

such as access control systems, video management systems.

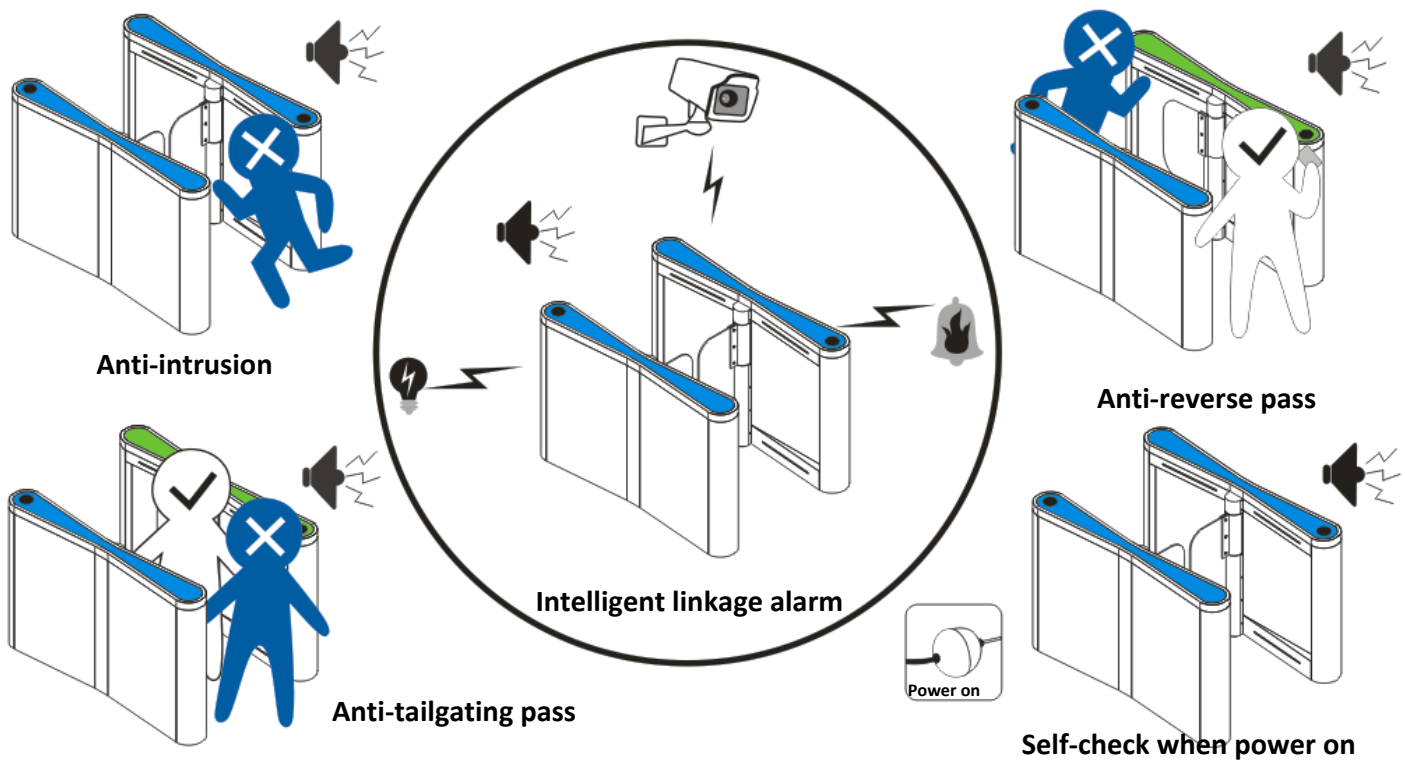

Custom-made Feature

● Customized Functions

- Built-in or external counter
- TCP / IP communication

● Gate open button

- External door open button.
- Install the gate open button with wireless remote control.

● Lane width

- The lane width can be custom-made for larger size, and the maximum can be 900mm, but the length might need to be changed according to the lane width.

➤ ★ Notes:

- (1) The product design and specifications are subject to change without prior notice.
- (2) Please contact us directly for special features customization.

● Materials

- The material of housing can be 316 grade stainless steel, and the thickness of stainless steel can be customized.
- The material of swing gate can be tempered glass, acrylic, polycarbonate etc. and the color can be customized.

● System Integration

- Integrate with access control system and built-in reader provided by customers.
- Integrate with visitor access control system.
- Integrate with ticketing system.